

TIME FOR INSTALLATION

3-4 HOURS

# RCI OFFROAD

ADVANCED



ADVANCED SKILLS  
REQUIRED

## 24+ Toyota Tacoma Arapaho Front Bumper Installation Guide

Contact RCI: [SALES@RCIOFFROAD.COM](mailto:SALES@RCIOFFROAD.COM)  
(970) 797-3089

Part Number	Description	Qty:
*	24+ Tacoma Gunnison Front Bumper	1
HW-00077	M10-1.25 x 30mm Hex Flange Bolt	6
HW-00130	M10 Nylock Nut	6
HW-00022	1/2 USS Flat Washer Thru Hard	12
HW-00017	1/4-20 x 7/8 Button Soc Cap Screw	5
HW-00019	1/4 USS Flat Washer Blk Zinc	10
HW-00031	1/4-20 Keps Nut 18-8 S.S. Black	5

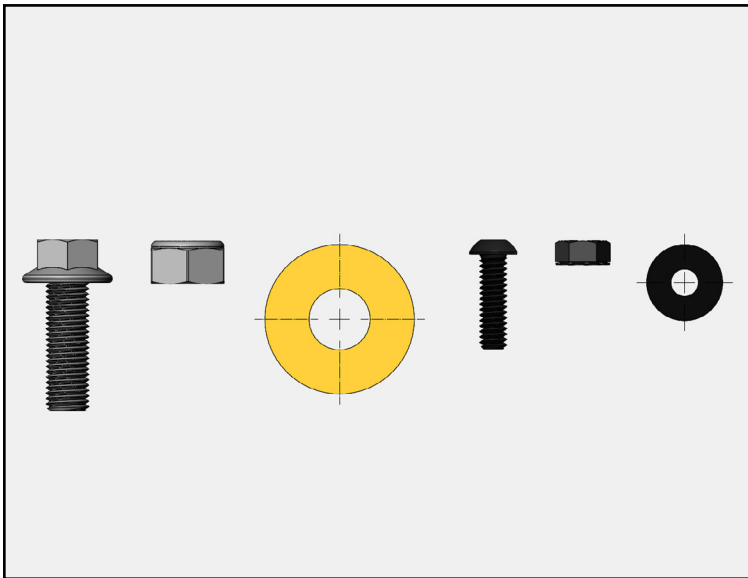

**Caution:** Use hand tools, impact wrenches may cause damage if over torqued.

**Read the entire notes and instructions before installation.**

## DISCLAIMER:

The products sold by RCI Metalworks are intended for off-road use only, should not be modified, and are for use only on the vehicle(s) specifically stated. RCI Metalworks makes no warranties express or implied, including of fitness for a particular purpose or merchantability. RCI Metalworks will not be liable for any damages arising out of the use or misuse of its products. It is the customers' responsibility to ensure the products are safely and properly attached to the vehicle, and all products should be installed by trained professionals. We strive to maintain extremely high-quality standards; however, all RCI Metalworks products are individually handcrafted, may vary slightly, and may contain minor imperfections. Due to the nature of raw aluminum, the material may have minor scratches and other blemishes caused by the manufacturing process, especially on the back side of the product. RCI Metalworks is constantly seeking to improve its products and reserves the right to make changes to any product.

Installation of an RCI bumper requires removal of factory-installed components such as crash bars and foam impact absorbers. These components are designed for vehicle safety and impact absorption, and their removal may negatively impact occupant protection in a crash. RCI is not responsible for the removal of these components, and the owner/installer assumes all risks associated with their removal and any resulting consequences. It is the owner/installer's sole responsibility to understand the implications of removing these components before proceeding with installation. The installation of this RCI bumper, improper installation of this RCI bumper, and use or misuse of this RCI bumper with other components or failure to use it in conjunction with other components, could result in or cause serious personal injury, property damage or death.

RCI bumpers are not crash-tested and are intended for off-road use only. Vehicle owners are responsible for testing and recalibrating any affected sensors after bumper installation. While RCI may conduct preliminary sensor functionality checks during product development, this does not constitute testing to Original Equipment Manufacturer (OEM) specifications. RCI is not responsible and does not accept liability, for breakage or failure of parts as a result of rugged off-road use or reckless and/or improper installation. Modifications to your vehicle are done at your own risk and RCI does not accept liability or responsibility arising from damage caused by installing parts or doing modifications.

RCI performs off-road testing on its bumpers, including winch pulls, static and dynamic recovery pulls, and general off-road use. However, RCI is not liable for any damages arising from the use or misuse of its products. Customers are responsible for ensuring products are safely and properly attached to their vehicle, and professional installation is strongly recommended. After installing any off-road product, customers should test and recalibrate all safety sensors to ensure proper functionality. Do not rely on any safety sensor functionality until this verification is complete.

RCI Offroad bumpers with receiver hitches are not load rated. Using a receiver hitch for towing or other heavy-duty tasks is not recommended unless explicitly stated by the manufacturer. The bumper and receiver hitch are intended for off-road recovery use and not designed for sustained towing or load-bearing applications. Any misuse, such as towing or overloading, may result in bumper failure, vehicle damage, or personal injury. RCI is not responsible for any damages or injuries resulting from the use of the bumper with a receiver hitch beyond its intended purpose.

If an RCI product is purchased by a third party, such as a dealer, wholesaler, or installer, it is the third party's responsibility to inform the end customer of this disclaimer.

# Installation Notes

## Installation Notes:

**RH** refers to the passenger side of the vehicle.

**LH** refers to the driver side of the vehicle.

Always use the proper torque specifications.

If applicable to this installation, torque specifications will be listed throughout the document.

Please read all of these instructions and familiarize yourself with the complete process **BEFORE** you begin.

## General Safety:

Park your car in a safe, well lit, level area.

Shut the engine off and remove the key from the ignition switch.

Make sure any remote start devices are properly disabled.

**ALWAYS** wear safety glasses.

Make sure the parking brake is applied until the vehicle is safely lifted and supported.

Whether lifting a vehicle using an automotive lift or a hydraulic jack, utilize the factory specified lift points.

Lifting a vehicle in an incorrect location can cause damage to the suspension/running gear.

**ALWAYS** support the vehicle with properly rated jack stands.

**ALWAYS** read and follow all safety information and warnings for the equipment you are using.

## Required Tools:

1/4", 3/8" & 1/2" Socket Sets & Ratchets

Floor Jack

Jack Stands

Combination Wrench Set

Plier Set

Torque Wrenches

## Installation Overview:

Before installation, remove all of the components and hardware from their packaging, then verify that all of the components and hardware are present.

# Section 1: Removing the Stock Components

## Step #1 | Painters tape & Marker

Remove all of the components and hardware from their packaging, then verify that all of the components and hardware are present.

Before removing the front grille and front bumper cover mask where the cut line will be to ensure clearance for the new RCI front bumper. Tape along at the edge (**YELLOW** lines) as shown and ensure that the tape wraps around the fender flares as shown. Measure 1/4" from the top edge of the tape and make a mark following the edge lines of the vehicle.

**Tech tip:** Double layer 3" painters tape for a more rigid tape line.



## Step #2 | Plastic Clip Removal Tool

Remove the plastic clips (**RED** circles) that secure the air-box inlet and upper radiator plastic panels to the core support. Remove them from the vehicle and set them aside.

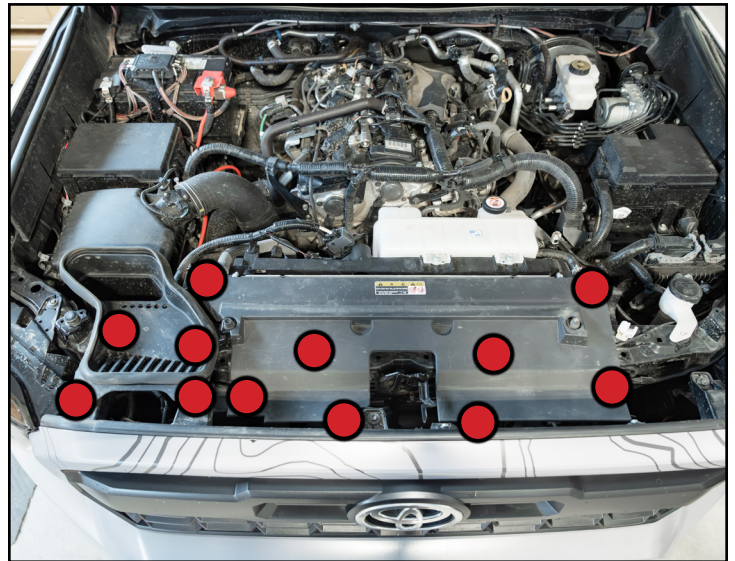

## Section 1: Removing the Stock Components

### Step #3 | 10mm Socket & Ratchet

Remove the screws (arrows) that secure the grille to the upper radiator core support and set the screws aside.

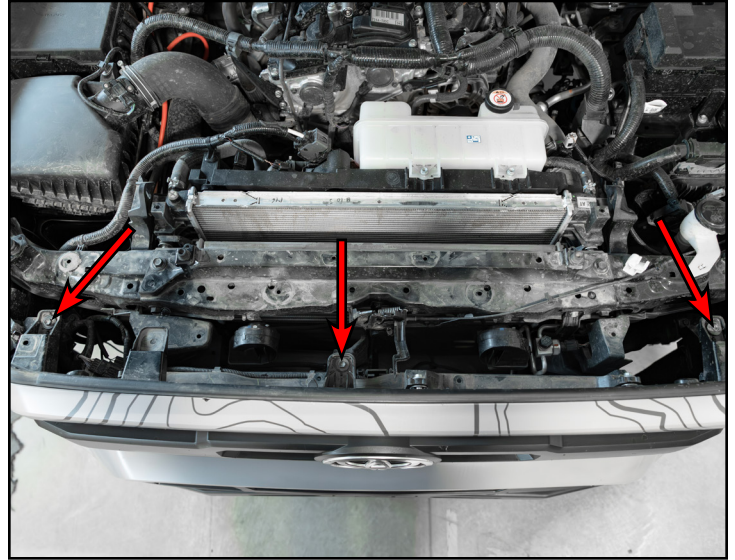

### Step #4

Disconnect the connectors for the wiring harnesses (highlighted in **RED**) from their connectors.

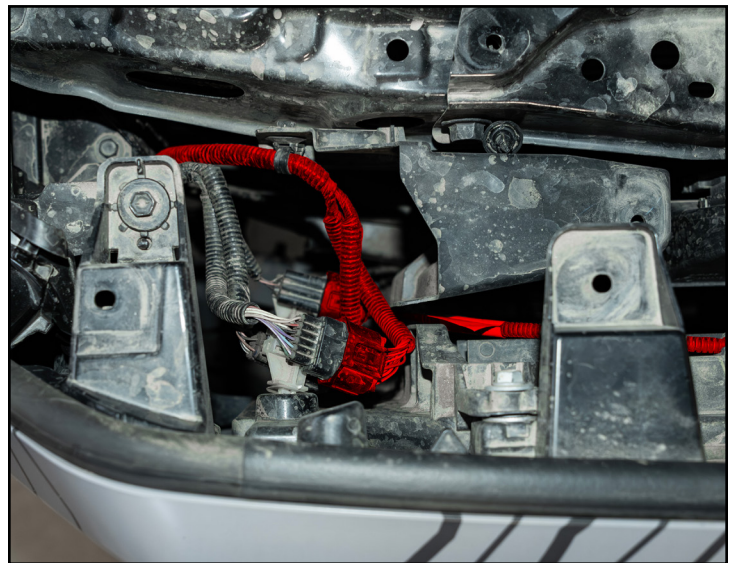

# Section 1: Removing the Stock Components

## Step #5 | 10mm Socket & Ratchet

Remove the screws (arrows) that secure the lower front bumper cover to the lower radiator core support.

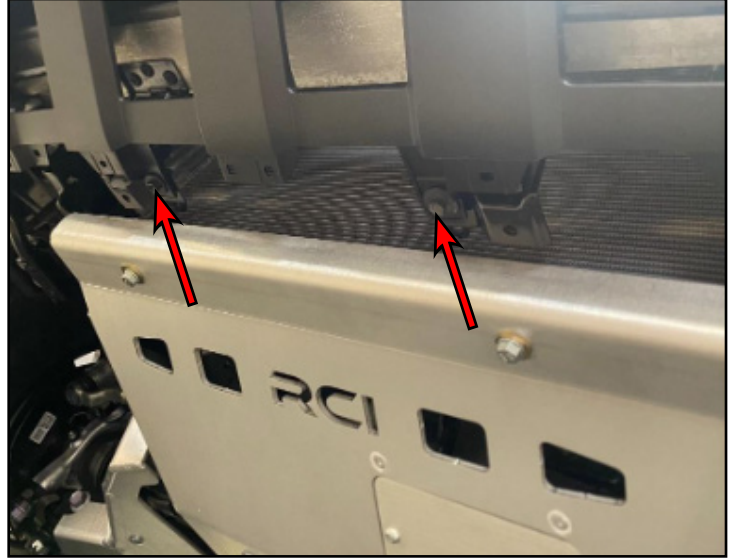

## Step #6 | 10mm Socket & Ratchet

Remove the screws (arrows in photo #1) that secure the fender liners to the bottom of the front bumper cover.

Remove the screws (arrows in photo #2) that secure the fender liner to the front bumper cover. Repeat for the opposite side.

**OPTIONAL:** All of the screws that secure the fender flares can be removed if you choose to cut the fender flares off of the vehicle.

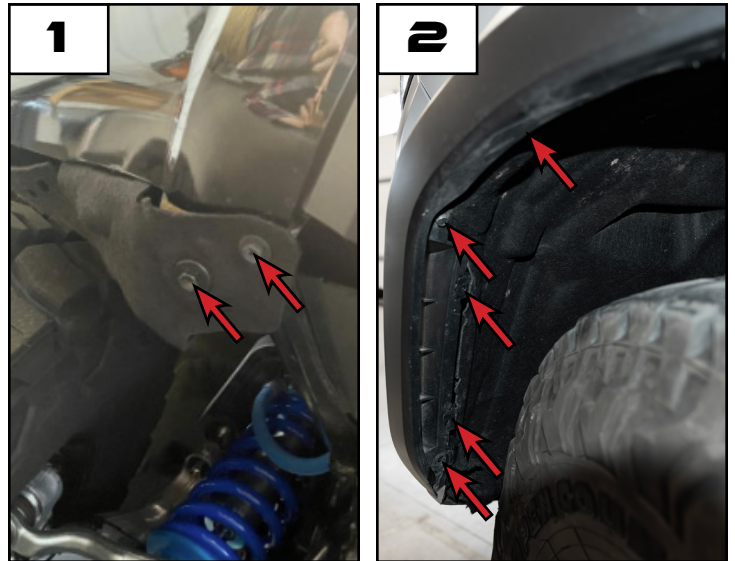

## Section 1: Removing the Stock Components

### Step #7

Starting at the bottom corner of the fender flare, pull the fender flare outward from the body of the vehicle and work upwards to free the flare from the front bumper cover.

**OPTIONAL:** If all of the screws were removed in the previous step the fender flare can be completely removed from the vehicle and set aside.



### Step #8 | Phillips Screwdriver

With the fender flare pulled back (optionally removed), remove the screw (arrow) that secures the front bumper cover and repeat for the opposite side.



## Section 1: Removing the Stock Components

### Step #9 | 10mm Socket & Ratchet

Remove the bolts (circled in **RED**) that secure the front bumper cover support bracket to the radiator core support.

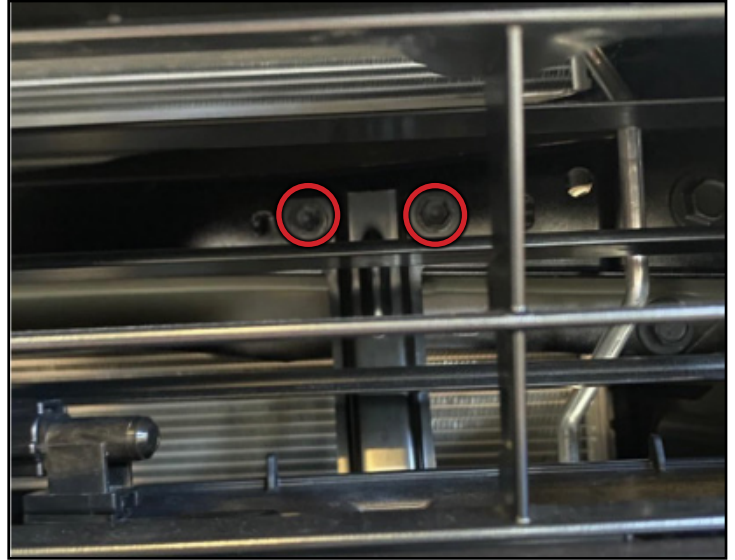

### Step #10

Disconnect the front bumper cover and front grille from the vehicle by starting at the side of the vehicle, near the fender, and then pulling outward until the retention clips are disconnected from their mounting locations. Repeat for the opposite side and work towards the center of the vehicle. Once all the retention clips are disconnected, remove the front grille and front bumper cover assembly from the vehicle and set it onto a suitable work surface.



## Section 1: Removing the Stock Components

### Step #11 | 17mm Socket & Ratchet

Remove the bolts (circled in **RED**) that secure the front crash bar to the vehicle frame, and set them aside. Remove the crash bar from the vehicle and set it aside.

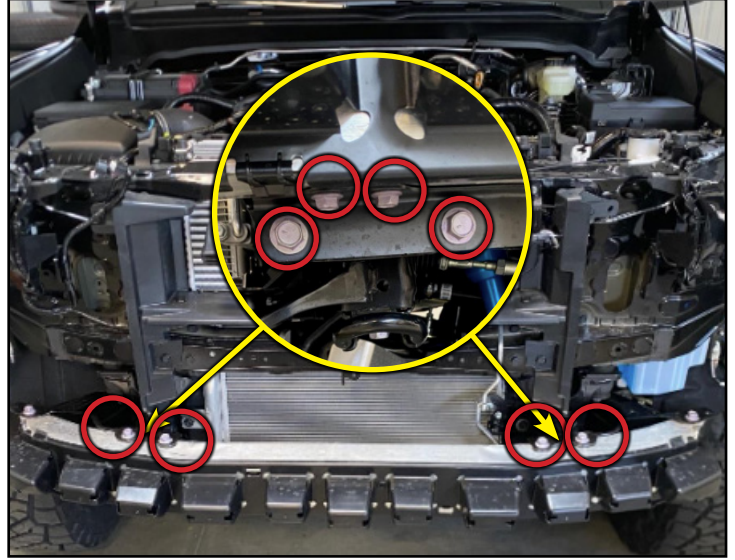

### Step #12 | Panel Clip Removal Tool

Remove the support bracket (as shown below) from the front grille. Disconnect the clips that secure the wiring harness (arrows) to the inside of the front bumper cover.

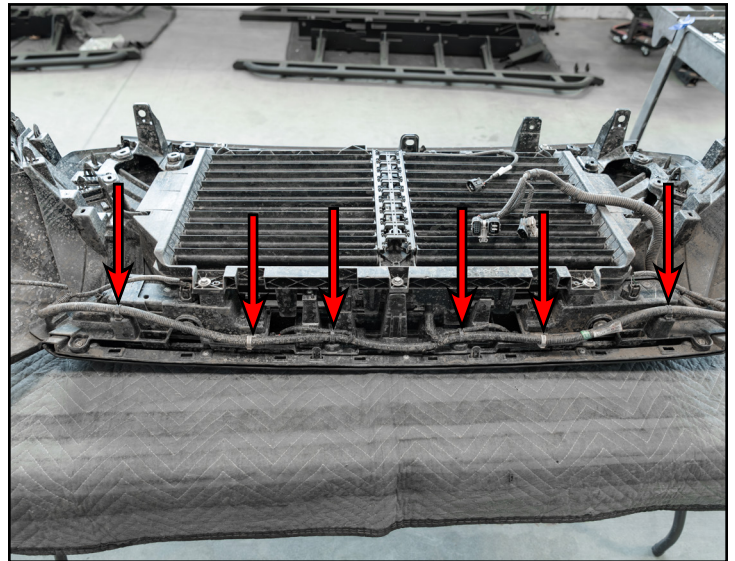
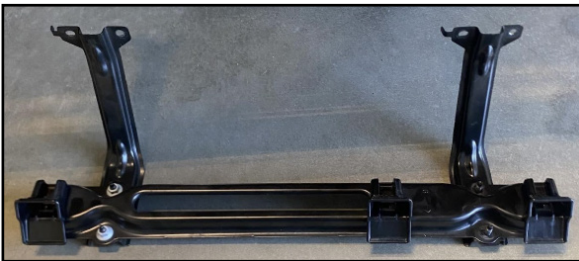

## Section 1: Removing the Stock Components

### Step #13

Disconnect the connectors (arrows) for the wiring harness (highlighted in **RED**) to the fog lights and front parking sensors.

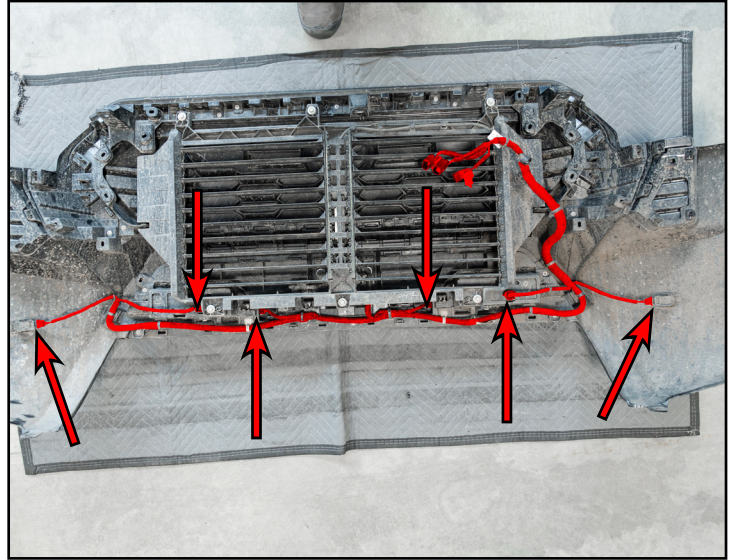

### Step #14 10mm Socket & Ratchet

Move the wiring harness out of the way to access the active front air dam. Remove the screws (circled in **RED**) that secure the active front air dam to the front grille, then remove the active air dam and set it aside.

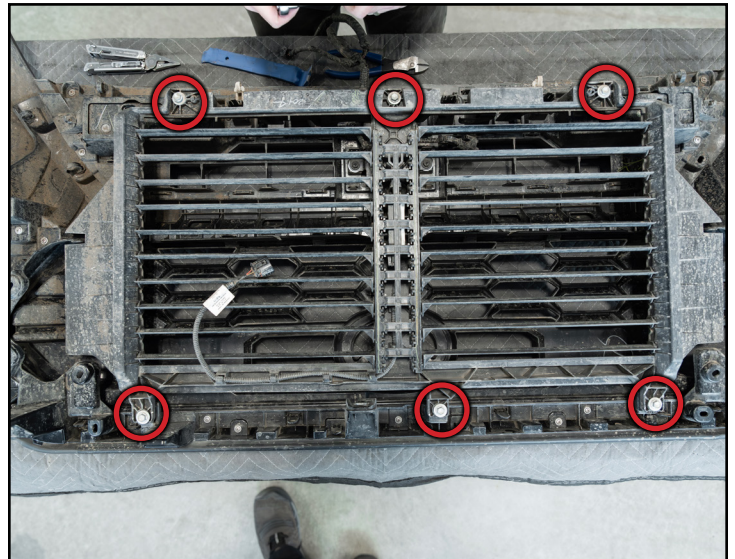

## Section 1: Removing the Stock Components

### Step #15

Disconnect the wiring harness (highlighted in **RED**) for the adaptive cruise control, then remove the harness and set it aside.

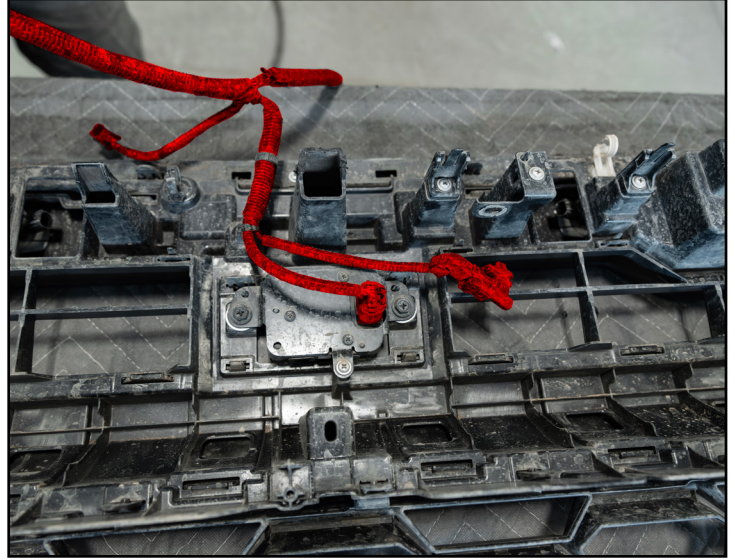

### Step #16 Flat Blade Screw Driver

Depress the tabs (arrows) to release the fog lights and plastic cover on the lower portion of the front grille, then remove them from the grille.

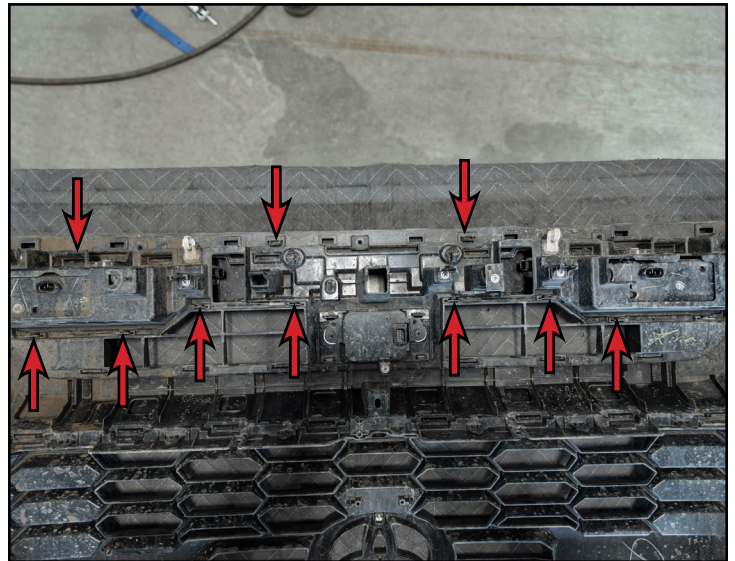

## Section 1: Removing the Stock Components

### Step #17 Panel Removal Tool

With the fog light panel removed, use a non-marring tool to remove the parking sensors (arrows) from the panel and set them aside.

**NOTE:** Take note of the orientation of the parking sensors prior to removal.

**Tech tip:** If the double sided adhesive was damaged during the removal process, clean as much of the old adhesive material from them as possible, then, apply new double-sided adhesive tape to the sensors as shown in the inset photo.

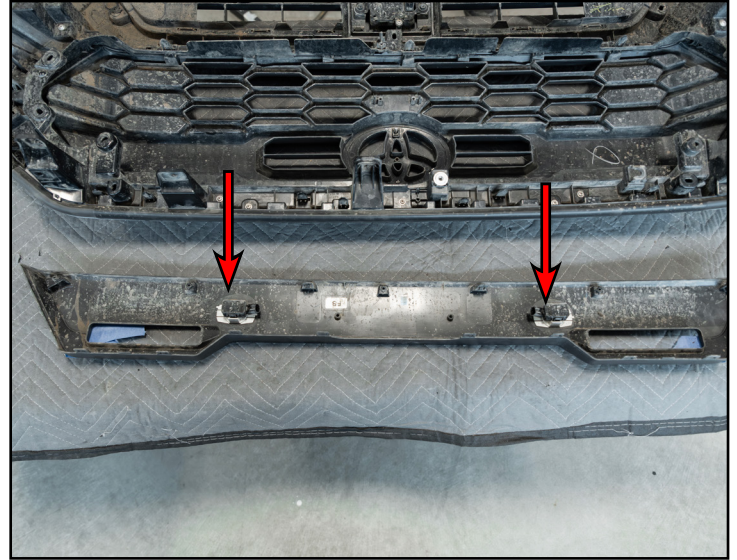

### Step #18 Panel Removal Tool

Remove the LH & RH parking sensors (arrows) using a non-marring tool, then set them aside.

**NOTE:** Take note of the orientation of the parking sensors prior to removal.

**Tech tip:** If the double sided adhesive was damaged during the removal process, clean as much of the old adhesive material from them as possible, then, apply new double-sided adhesive tape to the sensors as shown in the inset photo.

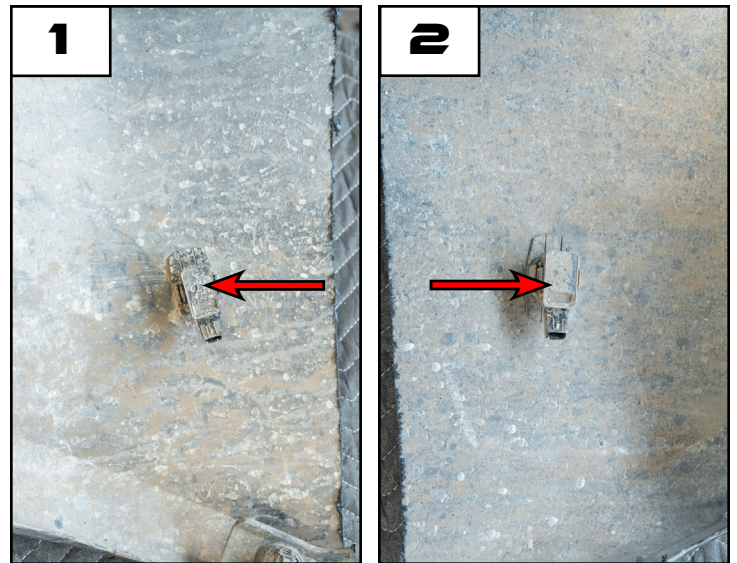

## Section 1: Removing the Stock Components

### Step #19 | Die Grinder -OR- Reciprocating Saw

Cut the front bumper cover along the previously marked lines and remove the lower center section (highlighted in **RED**).

**Tech tip:** Cut the front bumper below the previously made mark. Installing the front bumper cover & grille assembly once the new RCI front bumper is installed will determine if more material needs to be removed.



### Step #20 | Die Grinder -OR- Reciprocating Saw

Cut both fender flares to match the cut lines of the front bumper cover.

**Tech tip:** Cut the fender flare below the previously made mark. Installing the front bumper cover & grille assembly once the new RCI front bumper is installed will determine if more material needs to be removed.



## Section 1: Removing the Stock Components

### Step #21

**Optional:** As a guide for trimming the front bumper cover, the cover can be placed on top of the new bumper to visualize how the fitment between the front bumper cover and the new bumper will look.



### Step #22 Sander -OR- File

Once the desired fit has been achieved, deburr the edges from the cuts that were previously made.



## Section 2: Installing the New RCI Front Bumper

### Step #1 | 10mm Socket, Ratchet, 1/4" Bit & Drill

Reinstall the active air dam and secure it to the front grille assembly with the OEM bolts (**YELLOW** circles) that were previously removed.

Measure 1" from the center active air dam mounting base, make a mark, then drill a 1/4" sized hole (arrow in inset photo) to prepare it to be secured to the new RCI front bumper.

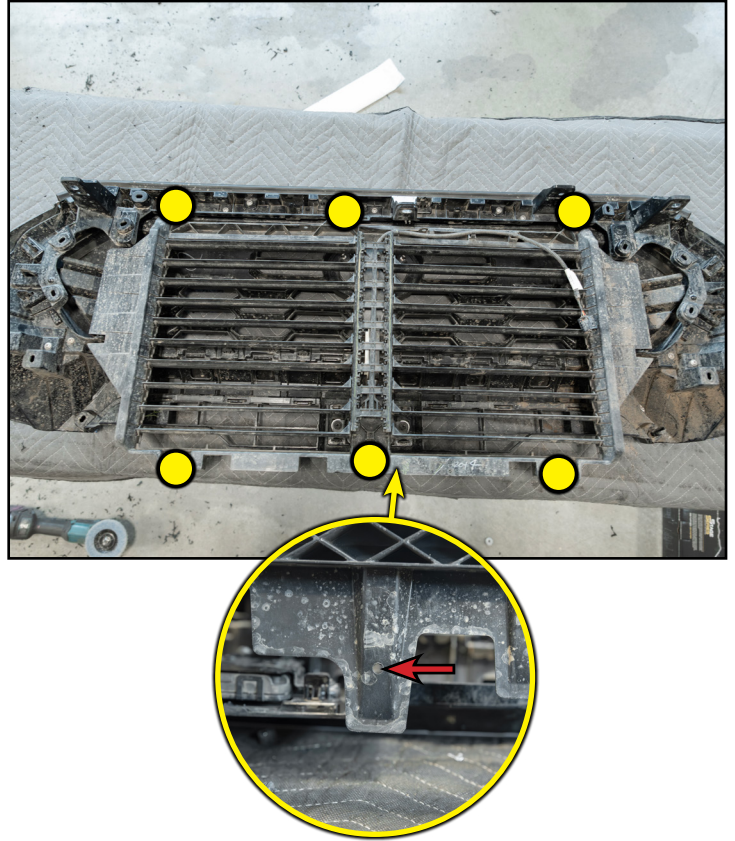

### Step #2

Prepare the new RCI front bumper with any desired accessories (winches, lights etc.) prior to installation.



## Section 2: Installing the New RCI Front Bumper

### Step #3

Install the center parking sensors (highlighted in **GREEN**) into the locations where they were previously removed from the OEM front bumper cover. Secure them into place.

**NOTE:** the sensors are angled and should match orientation from when they were previously installed in the OEM front bumper cover.



### Step #4

Install the LH & RH parking sensors (highlighted in **GREEN**) in the locations where they were previously removed from the OEM front bumper cover. Secure them into place.



## Section 2: Installing the New RCI Front Bumper

### Step #5 | 15mm, 17mm Socket & Ratchet

Lift the new RCI front bumper onto the existing front crash beam studs, then loosely re-install the OEM hardware (circled in **YELLOW** in inset photo), and the provided M10 hardware (arrows in inset photo) as oriented below. Adjust the front bumper inward and upward then fully tighten the previously installed hardware.

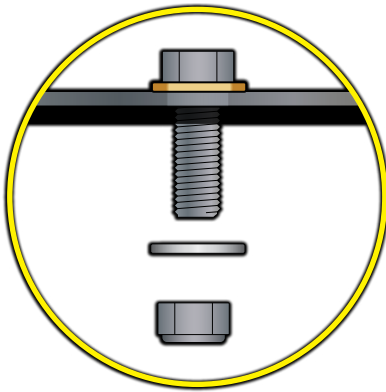

***\*M10 bolt orientation as shown:***

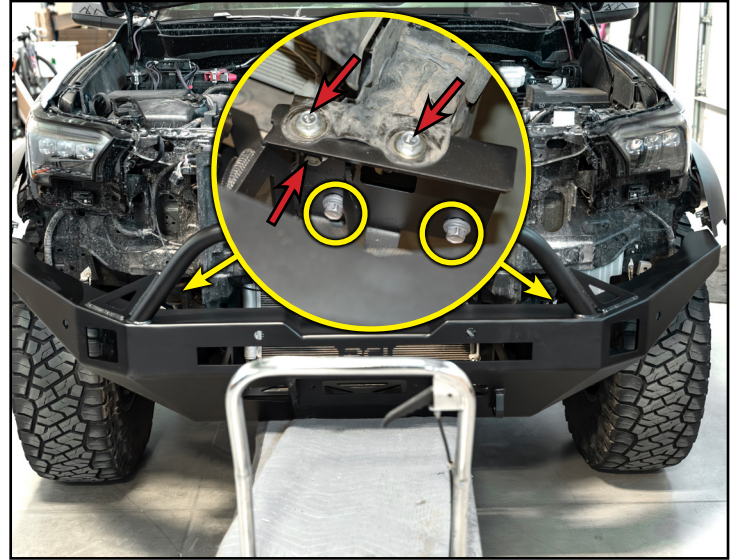

**Tech tip:** Having a friend to assist, along with using a floor jack and jack stands will make this installation easier.

**NOTE:** The OEM threaded stud is not utilized to secure the new front bumper to the vehicle.

### Step #6

Re-install the wiring harness (highlighted in **GREEN**) into place and re-connect the connectors for the parking sensors (not shown).

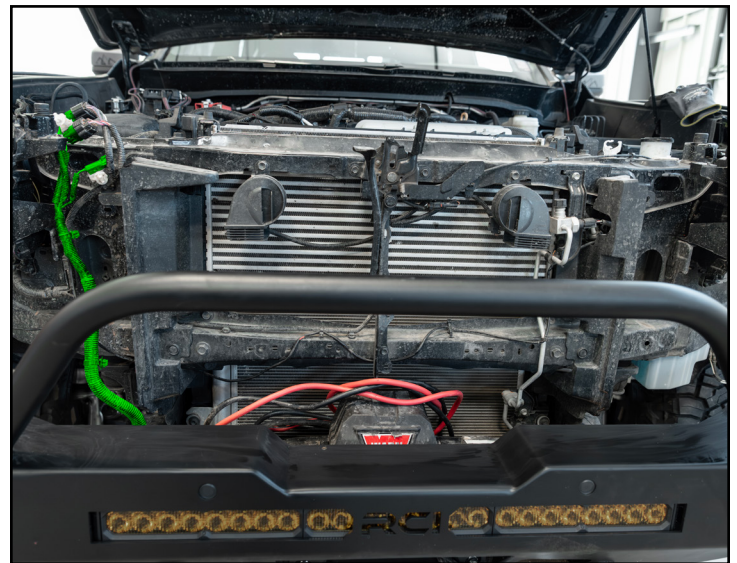

## Section 2: Installing the New RCI Front Bumper

### Step #7

Prior to re-installing the front grille and front bumper cover assembly, lift the front bumper cover into place, then re-connect the connector to the active cruise control (arrow).

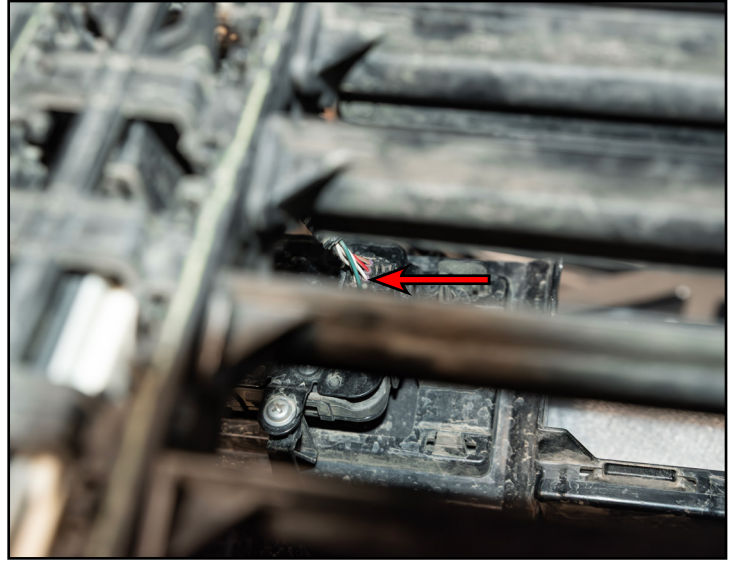

### Step #8

Align the front bumper cover with the retention tabs and press the assembly inward until it clicks into place.



## Section 2: Installing the New RCI Front Bumper

### Step #9

Reinstall the screw (arrow) to secure the front bumper cover sides to the vehicle.



### Step #10 10mm Socket & Ratchet

Secure the fender flares back into place with the previously removed OEM hardware.



## Section 2: Installing the New RCI Front Bumper

### Step #11 | 4mm Hex (Allen) & 11mm Wrench

Align the drilled hole on the base foot of the active air dam with the mounting location on the new RCI front bumper, then secure the bottom of the air dam using the provided 1/4" hardware (circled in **YELLOW**).



### Step #12

Reconnect the wiring harness (highlighted in **GREEN**) to their connectors.

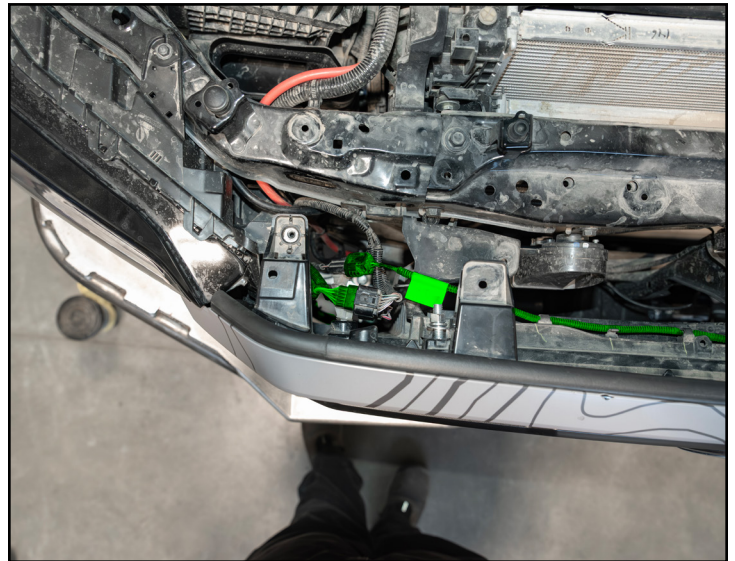

## Section 2: Installing the New RCI Front Bumper

### Step #13 | 10mm Socket & Ratchet

Secure the upper front grille to the radiator core support with the previously removed OEM bolts (circled in **YELLOW**).

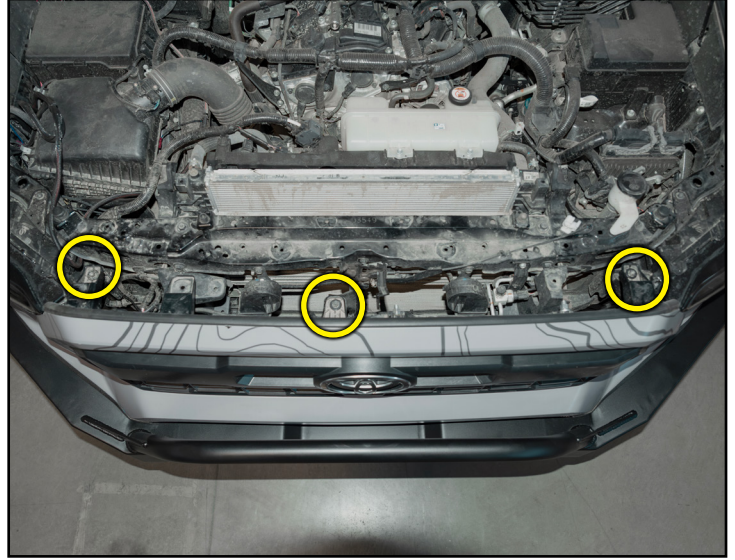

### Step #14

Reinstall the plastic cover and air inlet and secure them with the plastic clips (**YELLOW** circles).

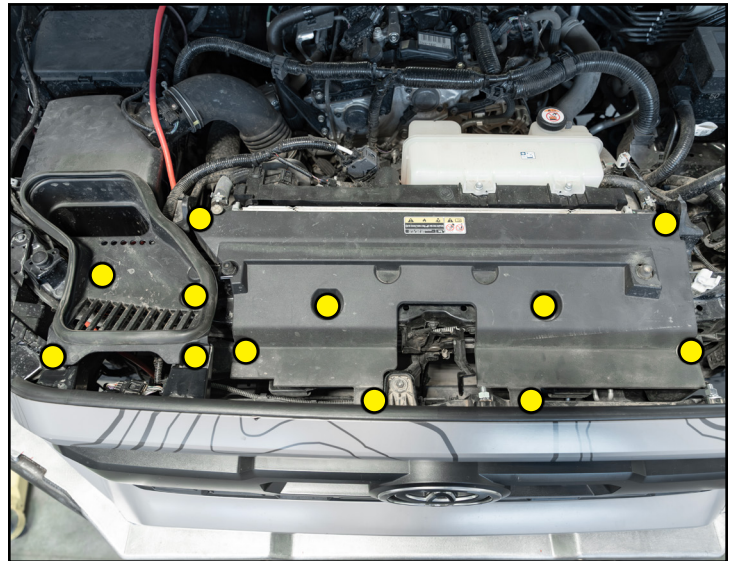

**CONGRATULATIONS, YOUR INSTALLATION IS COMPLETE!**

**ENJOY YOUR NEW RCI BUMPER!**



**Share your new install with us on social media!  
We love seeing our products in the wild!**

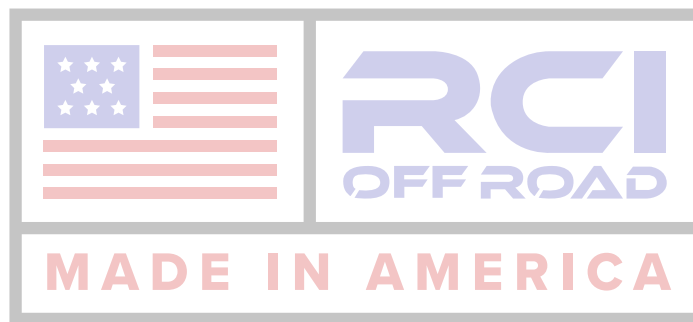

**Follow us on social media:**  
[instagram.com/rcioffroad/#](https://www.instagram.com/rcioffroad/)  
[facebook.com/RCIOffroad](https://www.facebook.com/RCIOffroad)  
[youtube.com/@RCIOFFROAD](https://www.youtube.com/@RCIOFFROAD)

**Contact:**  
1.970.797.3089  
[SALES@RCIOFFROAD.COM](mailto:SALES@RCIOFFROAD.COM)  
6701 N. FRANKLIN AVE. LOVELAND, CO 80538

**These instructions are provided as a courtesy by RCI Offroad**

Disclaimer: The products sold by RCI Metalworks are intended for off-road use only, should not be modified, and are for use only on the vehicle(s) specifically stated. RCI Metalworks makes no warranties express or implied, including of fitness for a particular purpose or merchantability. RCI Metalworks will not be liable for any damages arising out of the use or misuse of its products. It is the customers' responsibility to ensure the products are safely and properly attached to the vehicle, and all products should be installed by trained professionals. We strive to maintain extremely high-quality standards; however, all RCI Metalworks products are individually handcrafted, may vary slightly, and may contain minor imperfections. Due to the nature of raw aluminum, the material may have minor scratches and other blemishes caused by the manufacturing process, especially on the back side of product. RCI Metalworks is constantly seeking to improve its products and reserves the right to make changes to any product.