

TIME FOR INSTALLATION

3-4 HOURS



ADVANCED



ADVANCED SKILLS & EXPERIENCE REQUIRED

22+ Toyota Tundra Arapaho Front Bumper Installation Guide

Contact RCI: SALES@RCIOFFROAD.COM
(970) 797-3089

Part Number	Description	Qty:
SB-00192	22+ Tundra Arapaho Front Bumper	1
HK-00137	22+ Tundra Pike Bumper Hardware Kit	1
HW-00022	1/2 USS Flat Washer Thru Hard	12
HW-00077	M10-1.25 x 30mm Hex Flange	6
HW-00130	M10 Nylock Nut	6
HW-00026	3/8 USS Flat Washer Thru Hard	6
HW-00029	3/8 Split Lock Washer	4
HW-00030	3/8-16 FIN Hex Nut GR-5 Zinc	4
HW-00064	3/8-16 x 1-1/8 Hex Cap Screw	2
HW-00052	3/8-16 x 1 Carriage Bolt GR-5	2

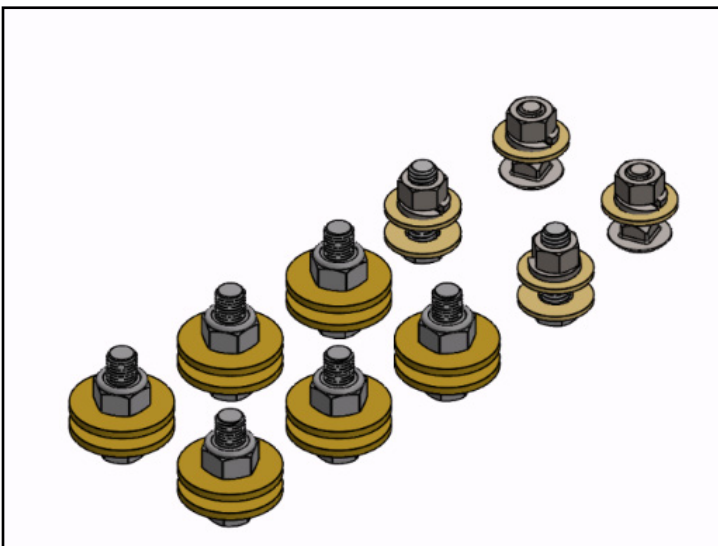
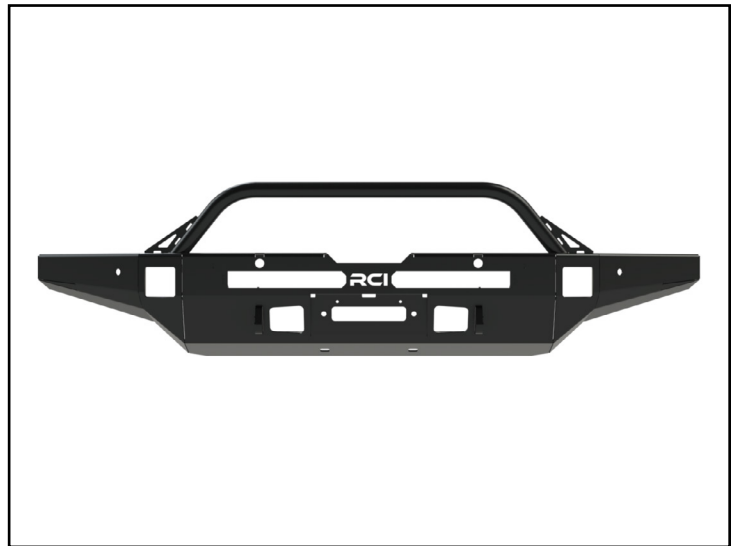

Caution: Use hand tools, impact wrenches may cause damage if over torqued.

Read the entire notes and instructions before installation.

DISCLAIMER:

The products sold by RCI Metalworks are intended for off-road use only, should not be modified, and are for use only on the vehicle(s) specifically stated. RCI Metalworks makes no warranties express or implied, including of fitness for a particular purpose or merchantability. RCI Metalworks will not be liable for any damages arising out of the use or misuse of its products. It is the customers' responsibility to ensure the products are safely and properly attached to the vehicle, and all products should be installed by trained professionals. We strive to maintain extremely high-quality standards; however, all RCI Metalworks products are individually handcrafted, may vary slightly, and may contain minor imperfections. Due to the nature of raw aluminum, the material may have minor scratches and other blemishes caused by the manufacturing process, especially on the back side of the product. RCI Metalworks is constantly seeking to improve its products and reserves the right to make changes to any product.

Installation of an RCI bumper requires removal of factory-installed components such as crash bars and foam impact absorbers. These components are designed for vehicle safety and impact absorption, and their removal may negatively impact occupant protection in a crash. RCI is not responsible for the removal of these components, and the owner/installer assumes all risks associated with their removal and any resulting consequences. It is the owner/installer's sole responsibility to understand the implications of removing these components before proceeding with installation. The installation of this RCI bumper, improper installation of this RCI bumper, and use or misuse of this RCI bumper with other components or failure to use it in conjunction with other components, could result in or cause serious personal injury, property damage or death.

RCI bumpers are not crash-tested and are intended for off-road use only. Vehicle owners are responsible for testing and recalibrating any affected sensors after bumper installation. While RCI may conduct preliminary sensor functionality checks during product development, this does not constitute testing to Original Equipment Manufacturer (OEM) specifications. RCI is not responsible and does not accept liability, for breakage or failure of parts as a result of rugged off-road use or reckless and/or improper installation. Modifications to your vehicle are done at your own risk and RCI does not accept liability or responsibility arising from damage caused by installing parts or doing modifications.

RCI performs off-road testing on its bumpers, including winch pulls, static and dynamic recovery pulls, and general off-road use. However, RCI is not liable for any damages arising from the use or misuse of its products. Customers are responsible for ensuring products are safely and properly attached to their vehicle, and professional installation is strongly recommended. After installing any off-road product, customers should test and recalibrate all safety sensors to ensure proper functionality. Do not rely on any safety sensor functionality until this verification is complete.

RCI Offroad bumpers with receiver hitches are not load rated. Using a receiver hitch for towing or other heavy-duty tasks is not recommended unless explicitly stated by the manufacturer. The bumper and receiver hitch are intended for off-road recovery use and not designed for sustained towing or load-bearing applications. Any misuse, such as towing or overloading, may result in bumper failure, vehicle damage, or personal injury. RCI is not responsible for any damages or injuries resulting from the use of the bumper with a receiver hitch beyond its intended purpose.

If an RCI product is purchased by a third party, such as a dealer, wholesaler, or installer, it is the third party's responsibility to inform the end customer of this disclaimer.

Installation Notes

Installation Notes:

RH refers to the passenger side of the vehicle.

LH refers to the driver side of the vehicle.

Always use the proper torque specifications.

If applicable to this installation, torque specifications will be listed throughout the document.

Please read all of these instructions and familiarize yourself with the complete process **BEFORE** you begin.

General Safety:

Park your car in a safe, well lit, level area.

Shut the engine off and remove the key from the ignition switch.

Make sure any remote start devices are properly disabled.

ALWAYS wear safety glasses.

Make sure the parking brake is applied until the vehicle is safely lifted and supported.

Whether lifting a vehicle using an automotive lift or a hydraulic jack, utilize the factory specified lift points.

Lifting a vehicle in an incorrect location can cause damage to the suspension/running gear.

ALWAYS support the vehicle with properly rated jack stands.

ALWAYS read and follow all safety information and warnings for the equipment you are using.

Required Tools:

1/4", 3/8" & 1/2" Socket Sets & Ratchets

Floor Jack

Jack Stands

Combination Wrench Set

Plier Set

Torque Wrenches

Installation Overview:

Before installation, remove all components and hardware from their packaging and verify that all the components are present.

Section 1: Removing the Stock Components

Step #1 Masking Tape & Marker

Remove all of the components and hardware from their packaging, then verify that all of the components and hardware are present.

Before removing the front grille and front bumper cover mask where the cut line will be (**YELLOW** lines) to ensure clearance for the new RCI front bumper. Tape along at the edge that aligns with the OEM fog light locations and wrap the tape accordingly around the fender flares. Measure 1/4" from the top edge of the tape and make a mark following the edge lines of the vehicle.

Tech tip: Use a laser level to ensure the masked cut line is straight and level.



Step #2 10mm Socket & Ratchet

Remove the screws (circled in **RED**) that secure the grille to the upper radiator core support and set the screws aside.



Section 1: Removing the Stock Components

Step #3 Panel Clip Removal Tool

Disconnect the connectors for the wiring harnesses (highlighted in **RED**), then remove the plastic clips (arrows).

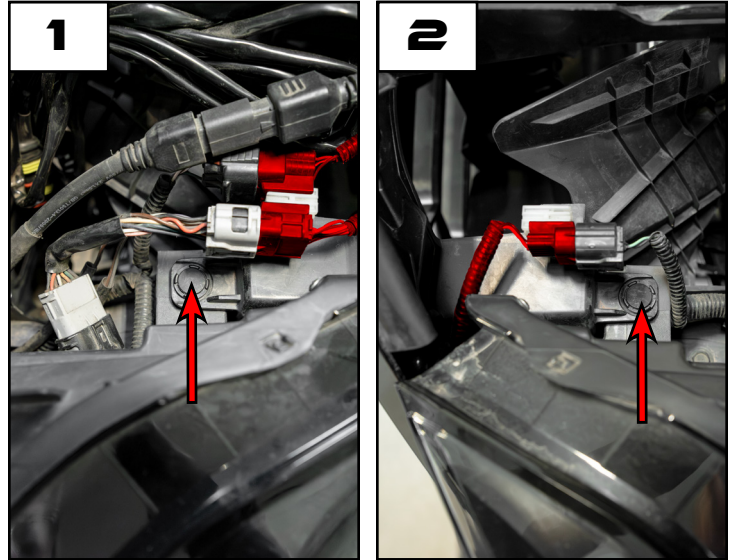

Step #4 10mm Socket & Ratchet

Remove the screws (circled in **RED**) that secure the fender flare to the front bumper cover and set them aside. Repeat for the opposite side.



Section 1: Removing the Stock Components

Step #5 | 10mm Socket & Ratchet

Remove the bolts (circled in **RED**) and the clips (arrows) that secure the fender liner to the front bumper cover and set them aside. Repeat for the opposite side.

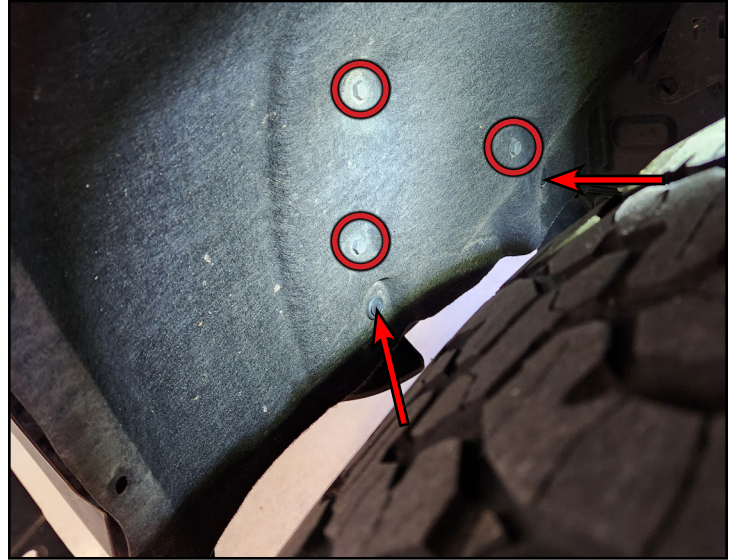

Step #6 | 10mm Socket & Ratchet

Remove the bolts (circled in **RED**) that secure the bottom of the front bumper cover to the bottom of the radiator core support.



Section 1: Removing the Stock Components

Step #7

Starting at the bottom front corner of the fender flare, pull outward away from the vehicle to release the fender flare from the front bumper cover.

Disconnect the side marker light harness (highlighted in **RED**) from the side marker light. Repeat for the opposite side.



Step #8 10mm Socket & Ratchet

Remove the bolts (circled in **RED**) that secure the front bumper cover support brackets to the radiator core support.



Section 2: Installing the New

Step #9

Disconnect the front bumper cover and front grille from the vehicle by starting at the side of the vehicle, near the fender, and then pulling outward until the retention clips are disconnected from their mounting locations.

Repeat for the opposite side and work towards the center of the vehicle.

Once all the retention clips are disconnected, remove the front grille and front bumper cover assembly from the vehicle and set it onto a suitable work surface.

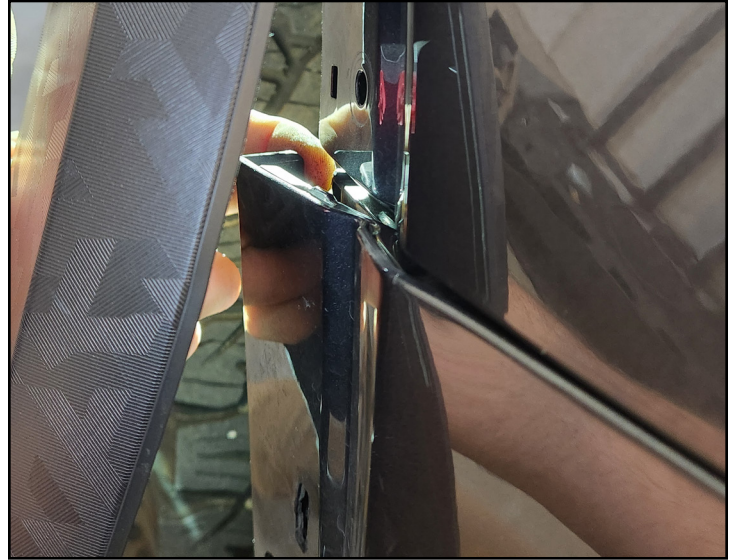

Step #10

If applicable: Disconnect the wiring harness (highlighted in **RED**) and connector from the air dam module. Free the retention clip (arrow) from its mounting location.

NOTE: For winch installations, the winch will not fit if the air dam module isn't deleted. It is recommended to install an aftermarket air dam delete module. If installing an air dam delete module, connect the delete module to the OEM connector.



Section 2: Installing the New

Step #11 | 17mm Socket & Ratchet

Remove the bolts that secure the front crash beam to the vehicle frame, and set them aside. Remove the crash beam from the vehicle and set it aside.



Step #12

Depress the tabs (arrows) to remove the support bracket from the front grille.

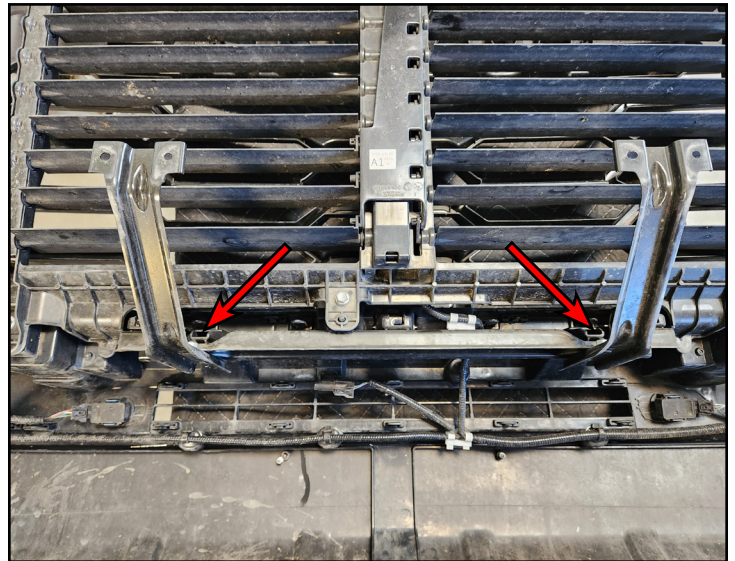

Section 2: Installing the New

Step #13 | Non-Marring Tool

Disconnect the clips (arrows) that secure the wiring harness to the inside of the front bumper cover.

Disconnect the connectors (circled in **RED**) for the wiring harness to the fog lights and front parking sensors.

Use a non-marring tool to remove the parking sensor mounts from the panels and set them aside.

NOTE: Take note of the orientation of the parking sensors prior to removal.

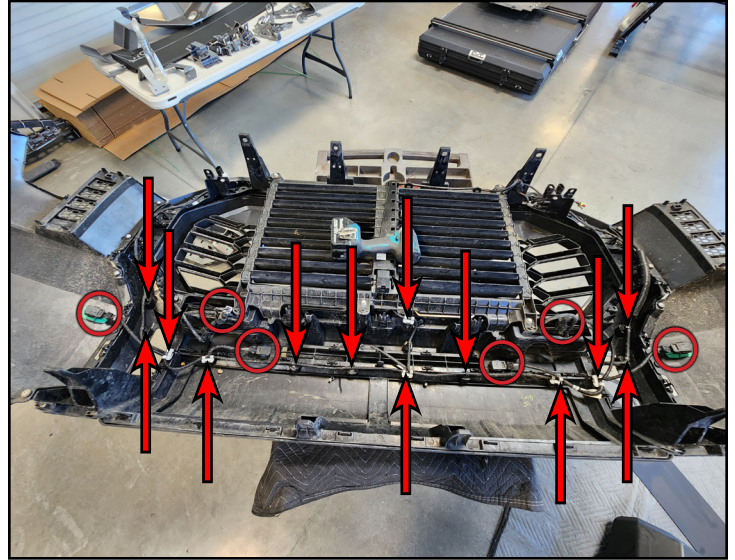

Tech tip: If the double sided adhesive was damaged during the removal process, clean as much of the old adhesive material from them as possible, then, apply new double-sided adhesive tape to the sensors as shown in the inset photo.

Step #14

Disconnect the wiring harness (highlighted in **RED**) for the adaptive cruise control, then remove the harness and set it aside.

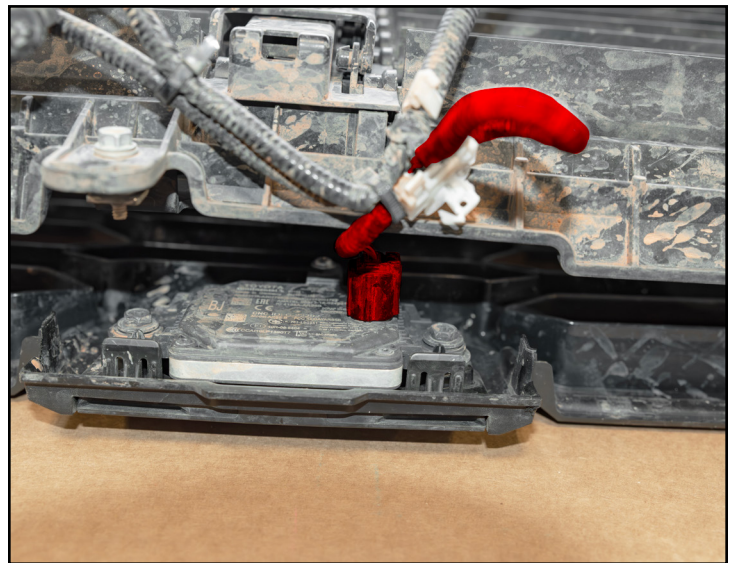

Section 1: Removing the Stock Components

Step #15 | 10mm Socket & Ratchet

Remove the screws (circled in **RED**) that secure the active air dam, then remove it and set it aside.

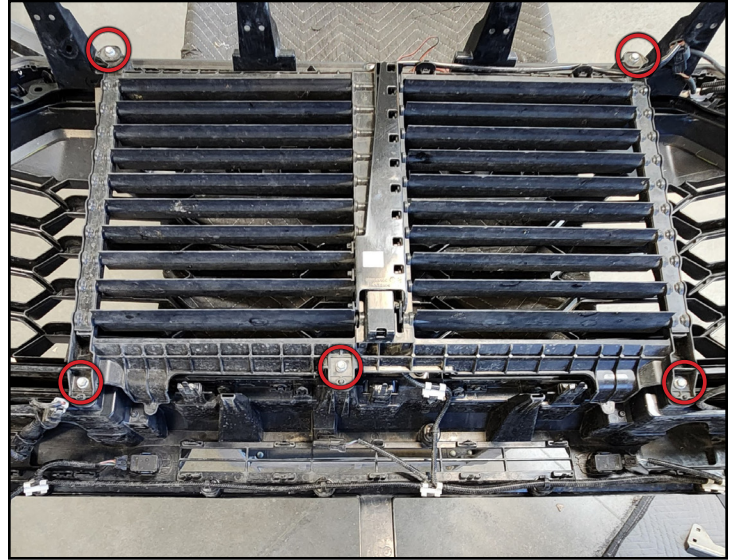

Step #16 | Cut Off Wheel –OR– Reciprocating Saw

Cut below the previously marked lines to start and remove the lower center section (highlighted in **RED**), then adjust the cut line as necessary.

Tech tip: After the initial cut, installing the front bumper cover & grille assembly once the new RCI front bumper is on will determine if more material needs to be removed.



***Note: Bumper is displayed on to show material being removed.**

Section 1: Removing the Stock Components

Step #17 | Cordless Sander -OR- File

Deburr the edges from the cuts that were previously made.



Step #18 | Cut Off Wheel -OR- Reciprocating Saw

Cut both fender flares to match the cut lines of the front bumper cover and deburr the edges from the cuts that were previously made.



Section 2: Installing the New Front Bumper

Step #1 | 10mm Socket & Ratchet

Reinstall the active air dam and secure it to the front grille assembly with the OEM bolts (**YELLOW** circles) that were previously removed.

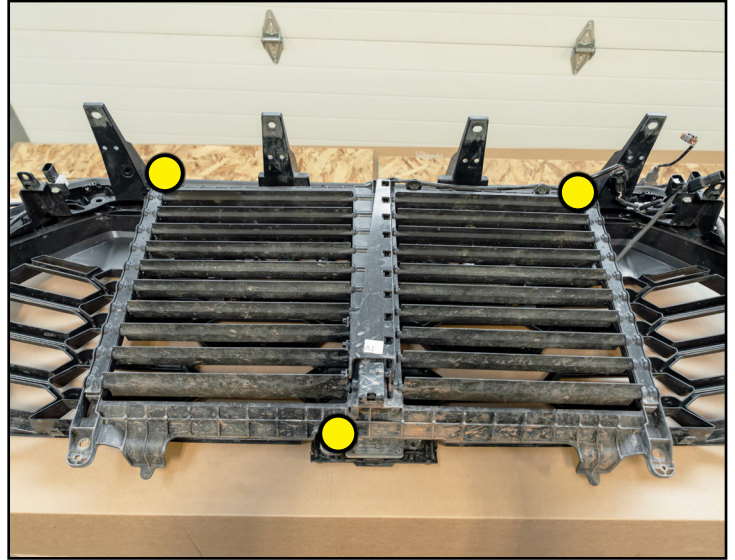

Step #2

Prepare the new RCI front bumper with any desired accessories (winches, lights etc.) prior to installation.

Tech tip: If installing a winch, the engagement lock needs to be clocked for clearance once the bumper is installed onto the vehicle.



Section 2: Installing the New Front Bumper

Step #3

Re-install the wiring harness (highlighted in **GREEN**) into place.

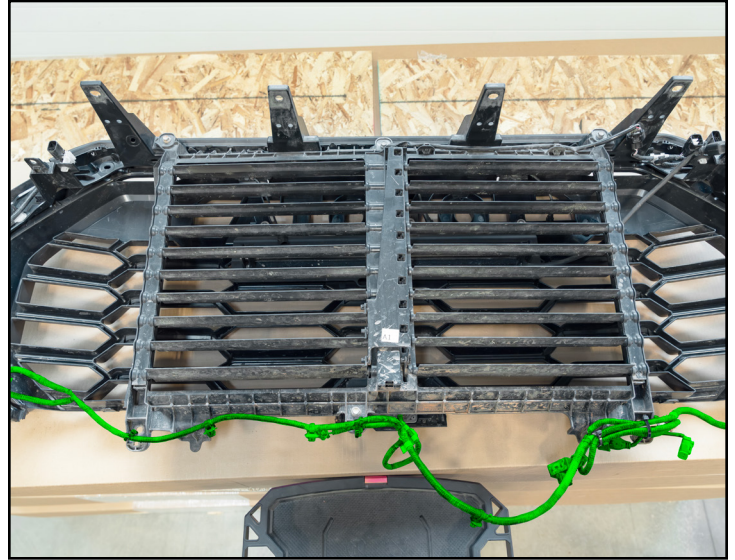

Step #4

Re-connect the ACC connector (highlighted in **GREEN**) to the module.

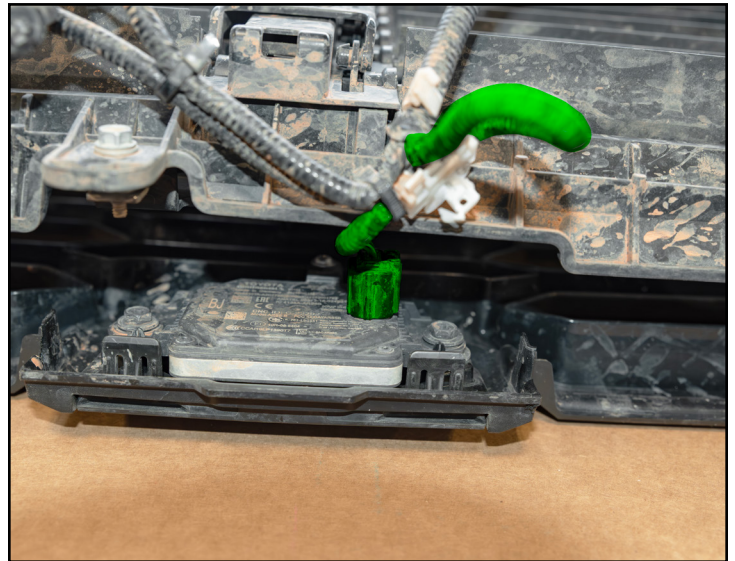

Section 2: Installing the New Front Bumper

Step #5

Install the center parking sensor mounts (arrows) into the locations where they were previously removed from the OEM front bumper cover.

NOTE: the sensors are angled and should match orientation from when they were previously installed in the OEM front bumper cover.

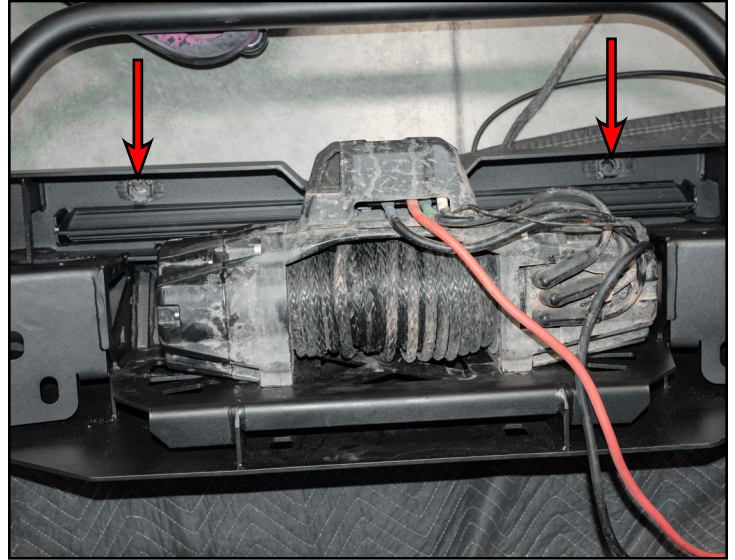

Step #6

Install the outer parking sensor mount (arrow) into the outer mounting locations. Repeat for the opposite side.

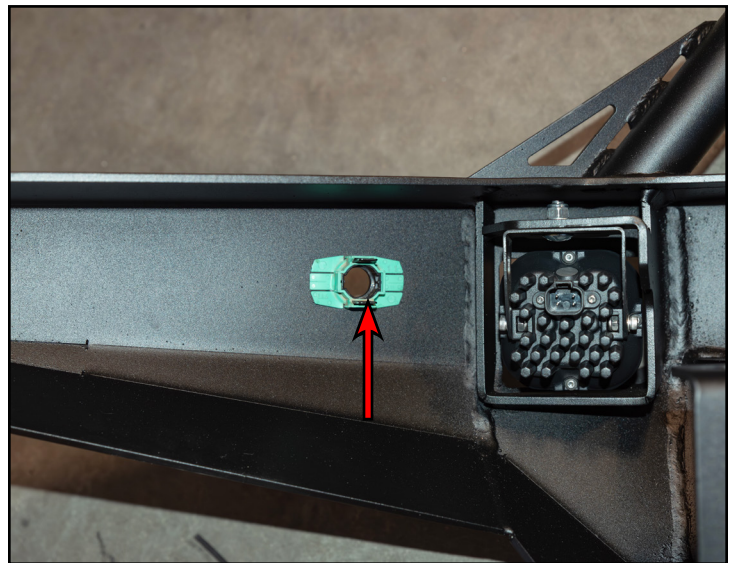

Section 2: Installing the New Front Bumper

Step #7 | 17mm Wrench, 15mm Socket & Ratchet

Install the provided full-moon spacers onto the existing studs (not shown). Lift the new RCI front bumper into place, then loosely install the provided M10 hardware (arrows in inset photo) into the upper verticle mounting locations.

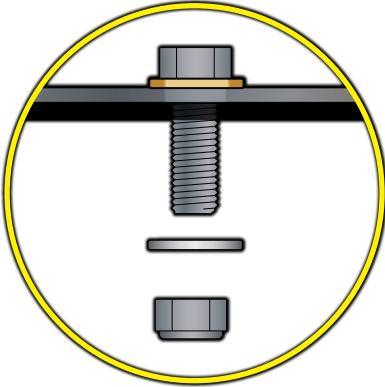

****M10 bolt orientation as shown:***

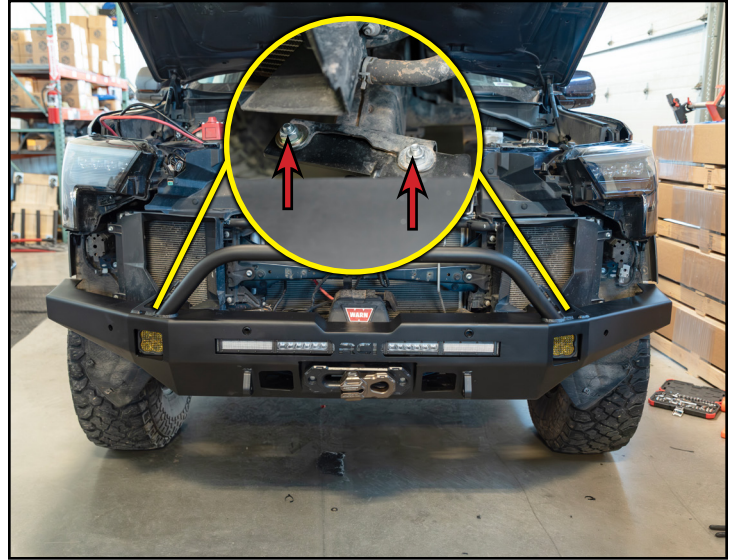

Tech tip: Having a friend to assist, along with using a floor jack and jack stands will make this installation easier.

Step #8 | 17mm Wrench, 15mm Socket & Ratchet

Loosely install OEM hardware (arrows), and the provided M10 hardware (circled in **YELLOW**). Adjust the front bumper inward and upward, then fully tighten the previously installed hardware.

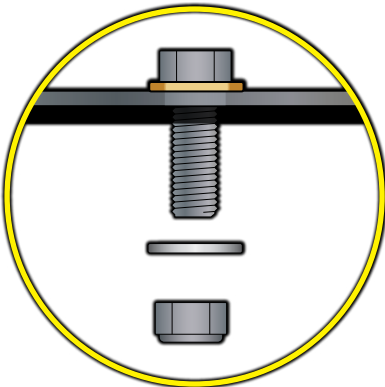

****M10 bolt orientation as shown:***

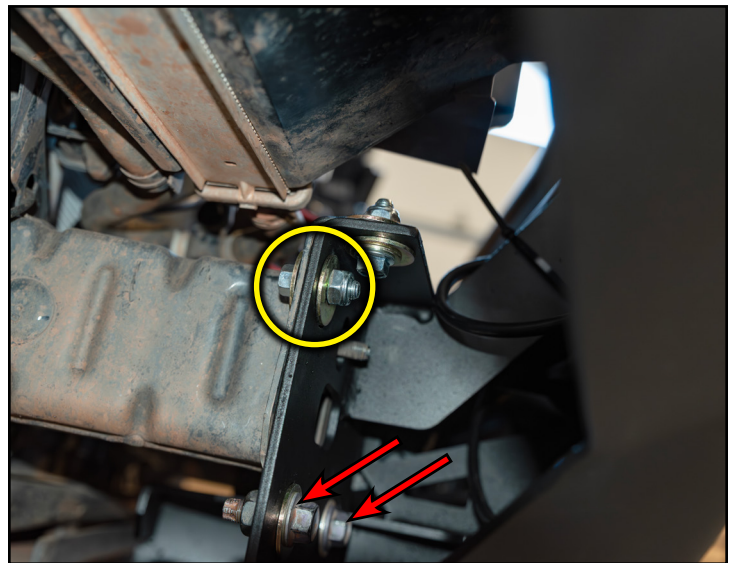

Section 2: Installing the New

Step #9

Install the parking sensors (arrows) into their mounts that were previously installed.

Reconnect the wiring harness connectors for the parking sensors (not shown).

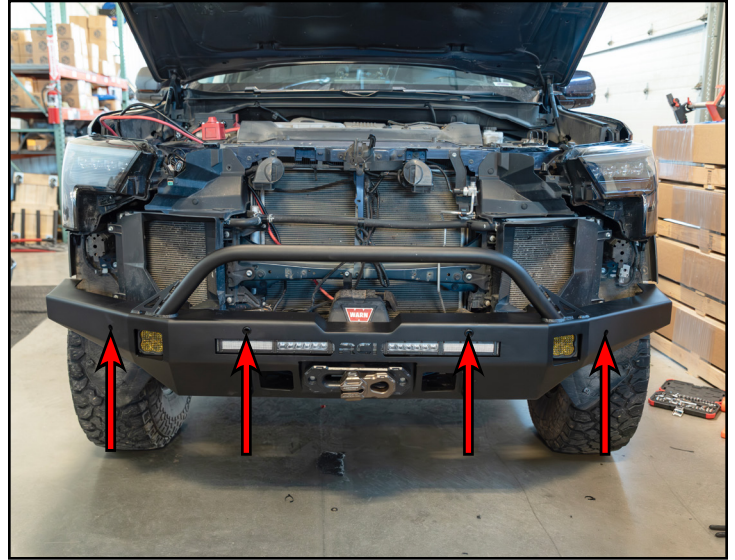

Step #10

Reinstall the front grille assembly and clip the mounting tabs into place.



Section 2: Installing the New

Step #11

Align the tabs on the fender flares with their mounting locations on the front grill sides and fenders, then press inward until they click into place.

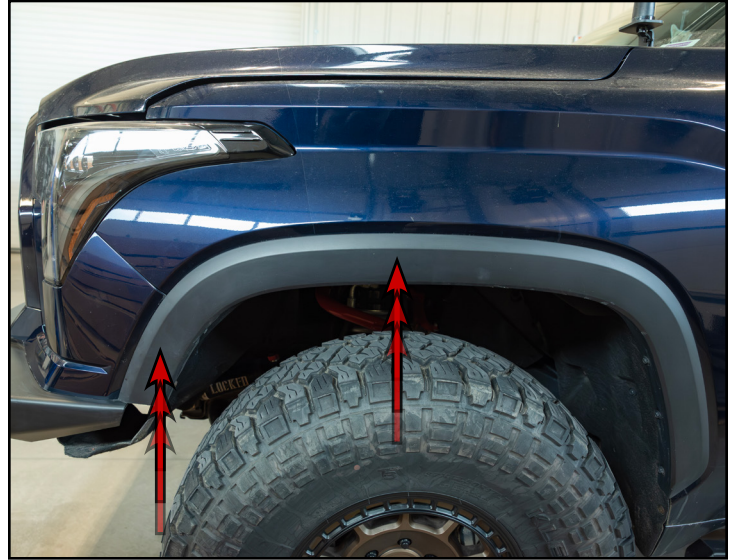

Step #12 10mm Socket & Ratchet

Secure the fender flares to the front grille and fenders by reinstalling the OEM hardware (circled in **YELLOW**).



Section 2: Installing the New

Step #13 | 10mm Socket & Ratchet

Secure the upper grille to the original mounting locations by reinstalling the OEM hardware (circled in **YELLOW**) that was previously removed.

Reinstall the clips (arrows) that were previously removed.

NOTE: There is a hole pre-drilled into the front bumper (**RED** circle) that a cable tie can be utilized to secure the base of the air dam to the bumper.

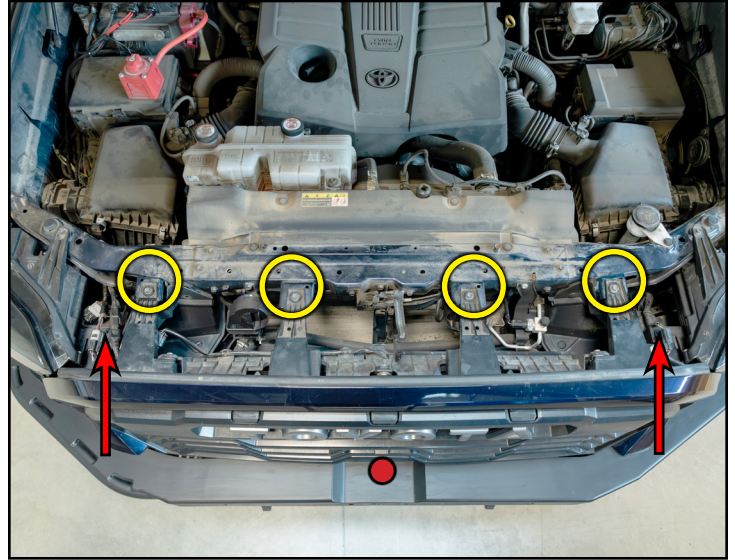

Step #14

Reconnect the connectors for the wiring harnesses (highlighted in **GREEN**).

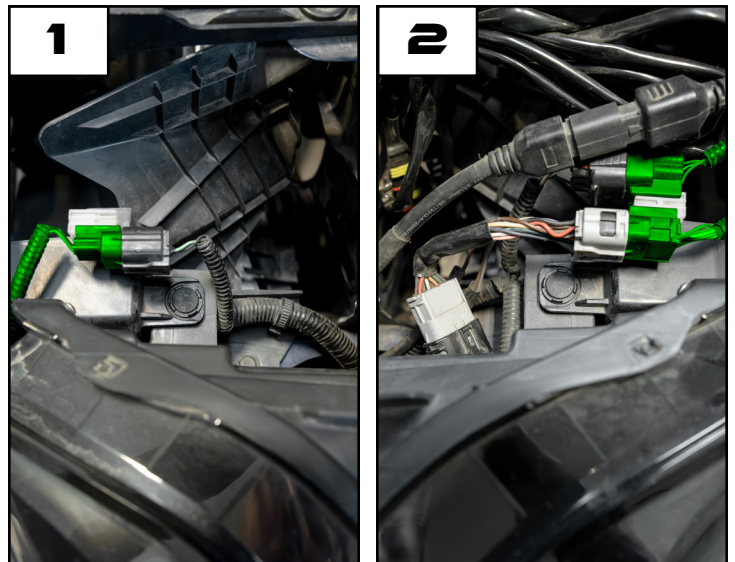

CONGRATULATIONS, YOUR INSTALLATION IS COMPLETE!

ENJOY YOUR NEW RCI PROTECTION!



**Share your new install with us on social media!
We love seeing our products in the wild!**

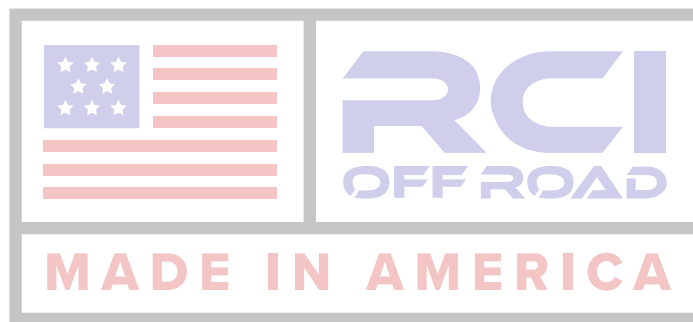

Follow us on social media:
[instagram.com/rcioffroad/#](https://www.instagram.com/rcioffroad/)
[facebook.com/RCIOffroad](https://www.facebook.com/RCIOffroad)
[youtube.com/@RCIOFFROAD](https://www.youtube.com/@RCIOFFROAD)

Contact:
1.970.797.3089
SALES@RCIOFFROAD.COM
6701 N. FRANKLIN AVE. LOVELAND, CO 80538

These instructions are provided as a courtesy by RCI Offroad

Disclaimer: The products sold by RCI Metalworks are intended for off-road use only, should not be modified, and are for use only on the vehicle(s) specifically stated. RCI Metalworks makes no warranties express or implied, including of fitness for a particular purpose or merchantability. RCI Metalworks will not be liable for any damages arising out of the use or misuse of its products. It is the customers' responsibility to ensure the products are safely and properly attached to the vehicle, and all products should be installed by trained professionals. We strive to maintain extremely high-quality standards; however, all RCI Metalworks products are individually handcrafted, may vary slightly, and may contain minor imperfections. Due to the nature of raw aluminum, the material may have minor scratches and other blemishes caused by the manufacturing process, especially on the back side of product. RCI Metalworks is constantly seeking to improve its products and reserves the right to make changes to any product.